

HYBRID MICROGRIDS: THE TIME IS NOW.

MICROGRIDS THAT COMBINE RENEWABLE ENERGY WITH DIESEL OR GAS GENERATOR SETS AND ENERGY STORAGE CAPABILITIES CAN DELIVER CLEAN, COST-EFFECTIVE ELECTRICITY TO REMOTE LOCATIONS WITH LIMITED OR NO ACCESS TO RELIABLE UTILITY POWER.

Francois-Xavier Saury

Caterpillar Inc.

Microgrid Business Development Manager for Europe, Africa, the Middle East and the Commonwealth of Independent States

Craig Tomlinson

Caterpillar Inc.

Electric Power Division - Microgrid Team

Product Support Readiness Manager

February 2016

CATERPILLAR®

INTRODUCTION

Cost-effective electric power has been a challenge for communities and industrial or commercial installations without access to a strong utility grid. They have had to rely on engine- or turbine-driven generator sets that, while highly reliable, typically produce power at a much higher cost than a large utility.

Now a better model is emerging that combines newly cost-effective renewable energy from wind or solar sources with conventional diesel- or gas-fueled generation. These installations, called hybrid microgrids, also employ energy storage to add power system stability and enable further energy cost reduction.

Aided by sharp declines in the cost of wind and solar energy, as well as lower energy storage costs relative to the price of fuel, hybrid microgrids are well suited to a host of applications, including individual buildings, resorts, mine sites, remote villages, small islands and others. The most promising applications are those with total power demand from 100 kW to 20 MW.

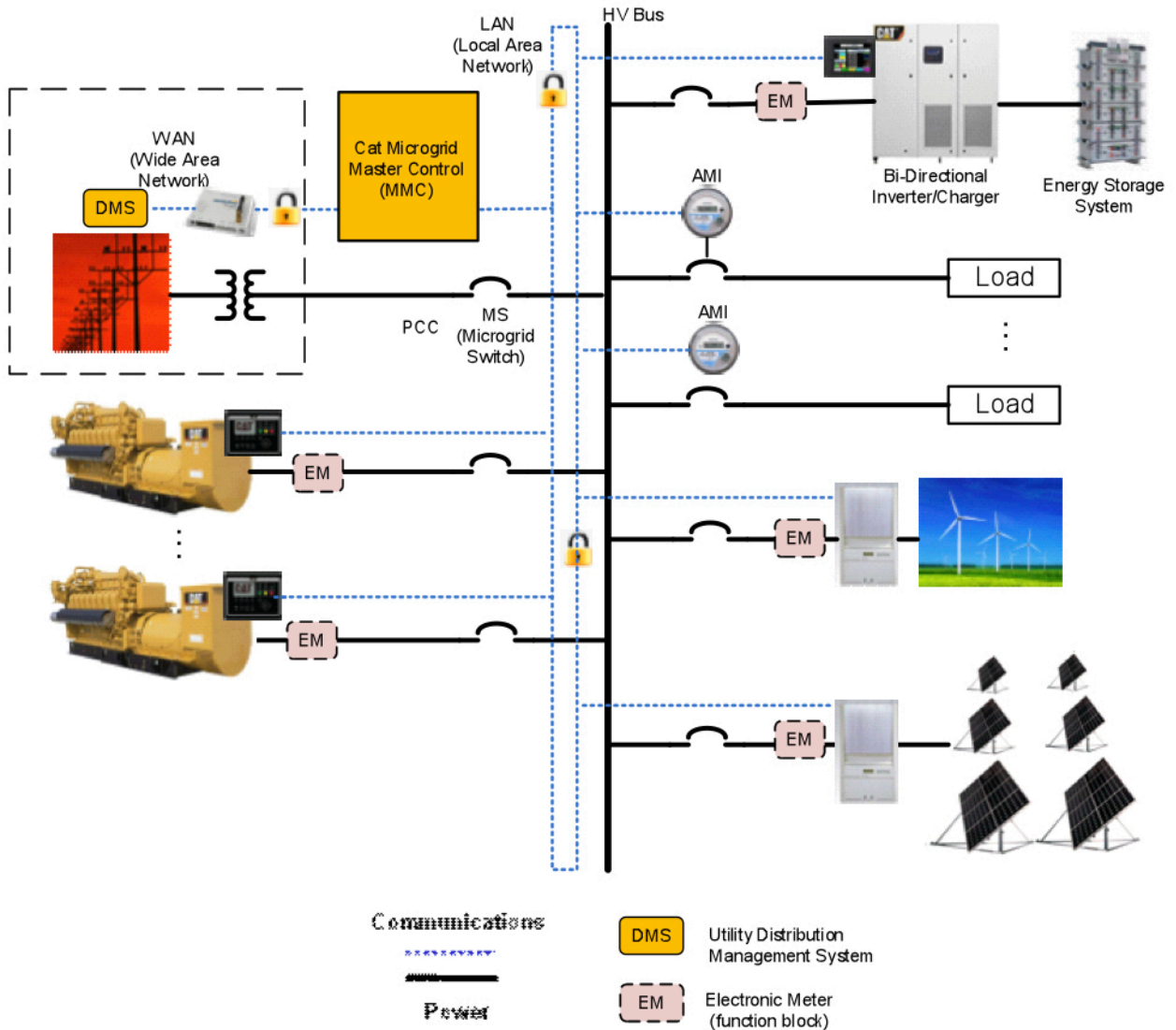

Figure 1: Typical single-line diagram of a hybrid microgrid

The basic concept is simple. Wind or solar energy reduces reliance on power produced from generator sets, saving fuel and, to a lesser extent, maintenance costs. The generator sets firm the renewable sources and follow the load. Sophisticated digital controls tie the system together. Energy storage enhances system economics and helps the generator sets respond smoothly to significant fluctuations in output from the renewable resources, while maintaining consistent voltage and frequency, as shown in Figure 1.

The hybrid microgrid concept is quickly becoming the preferred approach to delivering low-cost, reliable power in settings beyond the reach of larger electric utility infrastructure.

HYBRID MICROGRID DEFINED

The formal definition of a microgrid is a group of interconnected loads and distributed generation sources within a clearly defined electrical boundary that acts as a single controllable entity. Microgrids themselves are not new, as diesel and gas generator sets have been sold for several decades to power remote applications. These systems are continuously becoming more fuel-efficient as engine combustion and generator technologies improve.

What is new is an increase in hybrid microgrid systems that include renewable energy sources. Improvements in the costs and capabilities of photovoltaic (PV) systems, energy storage and telematics, along with advances in technology and communications, now economically justify hybrid applications that previously would have required special support or incentives. The integration of renewable technologies reduces operating expenses when compared to purely conventional generation, while also optimizing system reliability, efficiency and flexibility.

The concept has become increasingly attractive as the cost of energy from wind and solar PV generation has declined. Conversely, the cost of diesel fuel – usually the most available fuel for remote locations – has risen, as shown in Figure 2. In 2000, the levelized life-cycle energy cost of wind generation was similar to that of diesel, while solar energy was nowhere near being competitive.

Figure 2: Life-cycle cost trends, diesel vs. renewables

Sources: International Energy Agency, Lawrence Berkeley National Laboratories, National Renewable Energy Laboratory, U.S. Energy Information Administration, Clean Edge, Caterpillar.

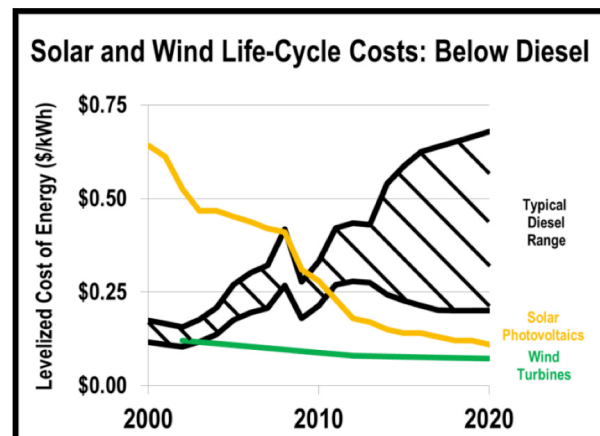

Since then, diesel fuel prices have mostly trended upward, while wind power prices trended slightly down and solar PV prices fell dramatically. Conservative projections place the price of wind energy at US\$0.09 per kWh by 2020, and the price of solar energy only slightly higher. This gives renewable energy a meaningful, long-term price advantage over diesel-generated power.

In addition, advances in energy storage, system control, power conditioning and connected load-side management have helped drive down the total cost of ownership of hybrid microgrid systems.

COMPLEMENTARY TECHNOLOGIES

The hybrid microgrid combines the benefits of renewable and conventional power generation while offsetting the weaknesses. The basic cost equation illustrated in Figure 3 demonstrates that, in return for higher capital cost, a hybrid microgrid delivers lower long-term operating cost and a lower total cost of ownership than pure conventional power generation.

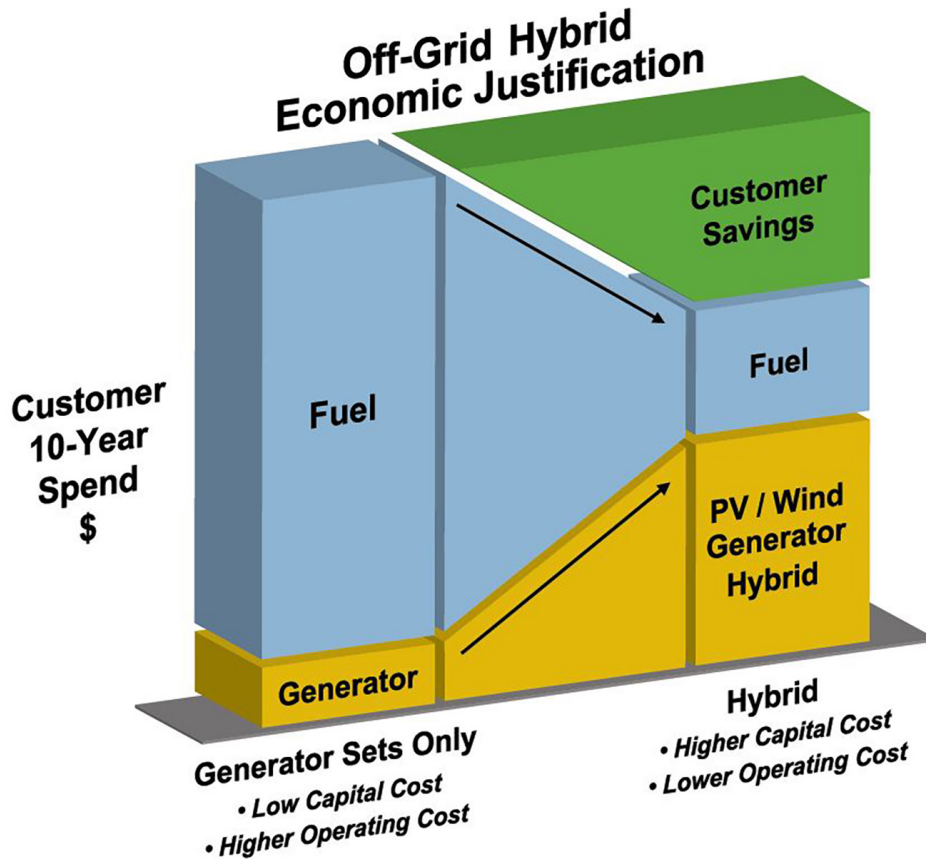

Figure 3. Basic hybrid microgrid economics

In a hybrid microgrid, renewable energy capacity can account for any percentage of the total peak load. In general, the greater the contribution from renewables, the greater the potential fuel and operating cost savings (Table 1).



Fuel savings objective			
	Renewable energy capacity	Energy storage function	
	30-100%	Greater than generator set capacity	Power stability and energy time shifting
	10-30%	Equal to generator set capacity	Power stability only
5-10%	<15-20% of generator set capacity	No energy storage	
Baseline	 Diesel or gas generator sets used for prime power		

Table 1: Microgrid renewable component vs. fuel savings

In a hypothetical system with a 3 MW peak load served by three 1 MW generator sets, a conservative approach would limit the renewable components to a small share of the capacity – for example, 300 kWp (10 percent). In this scenario, the renewables lower the fuel cost, but by far less than 10 percent because the intermittent nature of renewable energy can only offset a small share of generator set run time.

An intermediate approach would increase the renewables to 1 MWp (33 percent). Here, one generator set could shut down while the renewables produced at full capacity, saving significant fuel. If the renewable output declined suddenly, such as when a cloud shades a PV array, energy storage could provide short-duration intermittent power, achieving good system stability.

Optimally, renewables would total the full 3 MW or more. In that event, under ideal wind or sun conditions, the renewables could carry the entire load and at times inject the excess energy into storage for use later when wind or sun conditions are less favorable. This would result in long periods where no fuel is consumed from running the generator sets.

TECHNOLOGY VIRTUES

Each component of a hybrid microgrid brings advantages that strengthen the system as a whole.

Renewables

Wind and solar, while requiring higher capital and significant space, have minimal operating and maintenance costs once installed. They displace greenhouse gases and other pollutants and contribute strongly to sustainability initiatives.

Two basic types of solar PV systems can serve microgrids. The frameless thin-film technology has an energy conversion rate of about 20 percent and is well suited for hot, humid and dusty environments found in Australia, Africa and the Middle East, where its performance degrades at a lower rate than silicon panels. More costly mono crystal silicon technology is more efficient, delivering up to 25 percent energy conversion under ideal light and temperature conditions. It also requires less space than a thin-film system. However, more crystal silicon and poly crystal silicon cells degrade rapidly under hot, humid and dusty conditions rendering their performance advantage in the real world moot.

Generator sets

Reciprocating-engine generator sets deliver reliable energy and are fully dispatchable while renewable sources are offline or producing at less than rated capacity. Units in ratings from 350 kW to 15 MW and larger can be added in a modular fashion to create systems of substantial size. Multiple units add ample flexibility for variable load conditions.

Generator sets offer high power density, simple-cycle electrical efficiencies from 40 to 48 percent, high part-load efficiency and excellent capability to follow loads. They tolerate a wide range of ambient temperatures and high altitude without derating. Diesel units in particular accept load rapidly, with start times to full load as fast as 10 seconds and ramp-up time from 25 percent to 100 percent load in as little as 5 seconds. They tolerate unlimited starts and stops throughout the day with limited impact on service life or maintenance requirements. The technology is thoroughly proven and reliable, with hundreds of gigawatts of capacity installed and qualified service technicians readily available worldwide.

Generator sets also offer the potential for combined heat and power (CHP). Indeed, settings where microgrids are economically attractive – communities, resorts, industrial facilities – tend to have significant thermal requirements. Heat captured from engine exhaust or cooling circuits can be converted to steam, hot water, chilled water (by way of absorption chillers) or used in water desalination plants. In each case, the project economics can be greatly enhanced. In temperate climate zones, it is very attractive to combine CHP and solar energy because of their complementary nature. CHP capabilities are typically used during cooler times of the year when the solar contribution lessens. Energy storage helps to balance any surplus.

Energy storage

Energy storage is a key enabler of hybrid microgrids, thanks to rapidly advancing technology. The conventional energy storage system consists of banks of deep-cycle lead-acid, nickel-metal hydride batteries, flywheels or lithium-ion. However, two other energy storage technologies – ultra-capacitors and rechargeable metal-air – are now gaining favor.

Metal-air energy storage originated with hearing-aid batteries, providing long life in a safe and non-toxic package. More recently, a rechargeable capability has been developed for the zinc-air energy storage technology already common in applications such as backup power for cellular communication towers. The batteries can be 95 percent discharged and can be recharged with no cycle limit. Rechargeable zinc-air provides the most economical electricity storage, and it includes integrated controls and monitoring at the cell level.

Zinc-air batteries do not overheat or discharge dangerous concentrations of hazardous gases, and they operate in a range from freezing temperatures to 122°F (50°C) without derate. Life expectancy is at least twice as long as lead-acid batteries. The next generation of zinc-air storage will be offered in capacities at megawatt scale, well suited for the hybrid microgrid concept, and will provide an attractive total cost of ownership.

The range of energy storage technologies outlined above are used in microgrid applications today. A fully flexible offering enables a combination of these technologies, depending on the application.

SYSTEM INTEGRATION

Control over a hybrid microgrid is simpler than controlling combined renewables and conventional generation in a major utility. On a utility grid with wholesale deployment of wind or solar energy, the intermittent nature of the renewables could make the grid unstable absent massive energy storage or spinning reserve.

On a microgrid, digital controls and smaller-scale energy storage enable consistent voltage and frequency with reliable kVAR control. In the event of a voltage dip, for example, the energy storage can rapidly feed energy back into the system to provide stability. Energy storage also supports the generator sets in accepting block loads without fluctuations in frequency. This capability makes it possible to deploy renewable resources in proportions far greater than a utility grid could support – up to and exceeding total system demand.

A successful hybrid microgrid deployment depends on a fully integrated system. Ideally, a single party assumes responsibility for designing the hybrid microgrid and supplying all major components – generator sets, solar PV panels or wind turbines, energy storage and controls. This party also assumes responsibility for commissioning and long-term maintenance.

Today, the major components are available as factory-built, factory-tested, containerized modules that can be shipped to the site and installed with plug-and-play simplicity. This minimizes on-site construction work and shortens lead times.

ANALYZING COSTS

The key question is determining whether a hybrid microgrid is appropriate to a given site. Analytical tools are available that make it relatively easy to check economic feasibility. An initial high-level analysis requires little more than basic information about these several factors:

- The load profile of the community or facility to be served
- The site latitude and longitude and historic solar and wind conditions
- The cost of fuel for the primary power unit generator sets
- The cost of capital

The results of this analysis will indicate whether a deeper investigation is warranted or whether the project should be abandoned. HOMER microgrid analysis software can be used to perform a much more rigorous analysis for making a final decision. This software simulates one year of system performance, uses site-specific solar and wind energy data, and predicts annual hours of operation and fuel use for generator sets. The resulting data can then be used to develop an operating protocol that enables financial optimization of the system.

CASE STUDY: TROPICAL ISLAND

A power company serving a tropical island wanted a hybrid microgrid with PV energy and a diesel-fueled generation system to help reduce its costs.

The existing power generation equipment consisted of generator sets, fueled by No. 2 diesel distillate, supplied by Caterpillar. Table 2 presents a summary of the generating system, while Figure 4 shows the daily load profile.

Island Power Generation System Before Microgrid

Total generation capacity	10.7 MW
Average demand	1.6 MW
Peak demand	4.5 MW
Annual historic energy production	13,900,000 kWh

Table 2. Profile of island power generation system

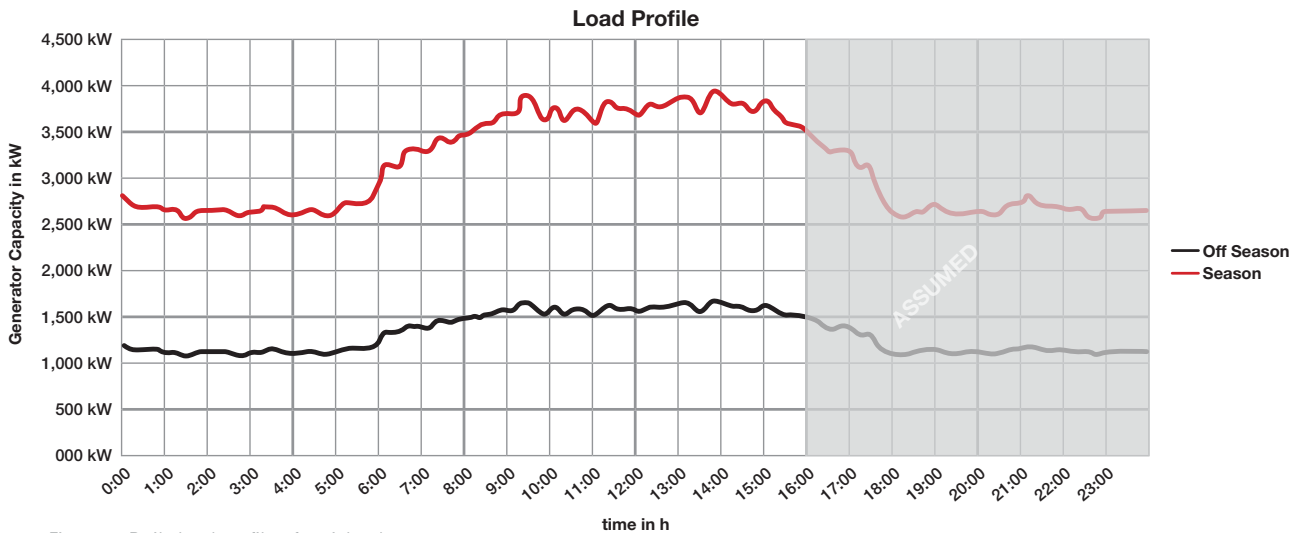

Figure 4. Daily load profile of an island power system

Evaluating renewable energy

To identify the optimal system design for the island’s needs, planners used the NASA EOSWEB database for global solar irradiation data, combined with the HOMER software tool. This enabled engineers to generate an estimate of the performance of a microgrid system incorporating renewable energy. The NASA data estimated the average annual solar irradiation to be 5.32 kWh/m²/day.

The analysis evaluated the site with a 670 kW solar PV system distributed over various rooftops. Table 3 shows the system analysis offered with and without energy storage to illustrate the financial benefits of energy storage systems.

Hybrid Microgrid System Analysis With and Without Energy Storage

MICROGRID OPTIONS	PV capacity (kW)	Fuel savings (%)	Fuel savings (gallons/yr)	Simple payback (years)
Baseline (as is)	0	0	0	0
Rooftop PV with grid stabilization	670	5%	53,373	6.4
Rooftop PV with grid stabilization and energy storage	670	7%	69,927	4.9

Table 3. Hybrid microgrid economic analysis

The analysis results showed a six-year payback simply from combining PV with the diesel. The payback fell below five years with the integration of a 250 kW energy storage system, even though that system would result in a higher total capital expense.

The system demonstrates the value of the microgrid concept in combining the benefits and offsetting the limitations of both renewable and conventional power generation. The system with integrated energy storage delivers rapid economic benefits along with enhanced power system stability and availability.

The system includes rooftop-mounted PV panels, since ground space was too scarce and too valuable for that purpose. It includes 2,316 solar modules and the racking structure needed to roof-mount the panels in various locations. String inverters are also included.

The energy storage system consists of one Cat® BDP250 bidirectional energy storage inverter and two strings of batteries. The inverter interacts with the power system frequency and voltage to add power when it is needed to compensate for energy fluctuations. The grid stabilization effect of integrating energy storage helps the overall power plant maintain system frequency and voltage in a narrower control band.

The system readily compensates for fluctuations in output from the solar panels. Figure 5 compares solar PV output for the array on a clear day and a cloudy day. During cloudy periods, solar energy generation can vary from 50 to 100 percent of the array capacity over short periods of 10 seconds or less. A sharp drop in PV output causes a sharp rise in the power required from the diesel generator sets. This causes a drop in system frequency and voltage as the diesel generators respond to the load.

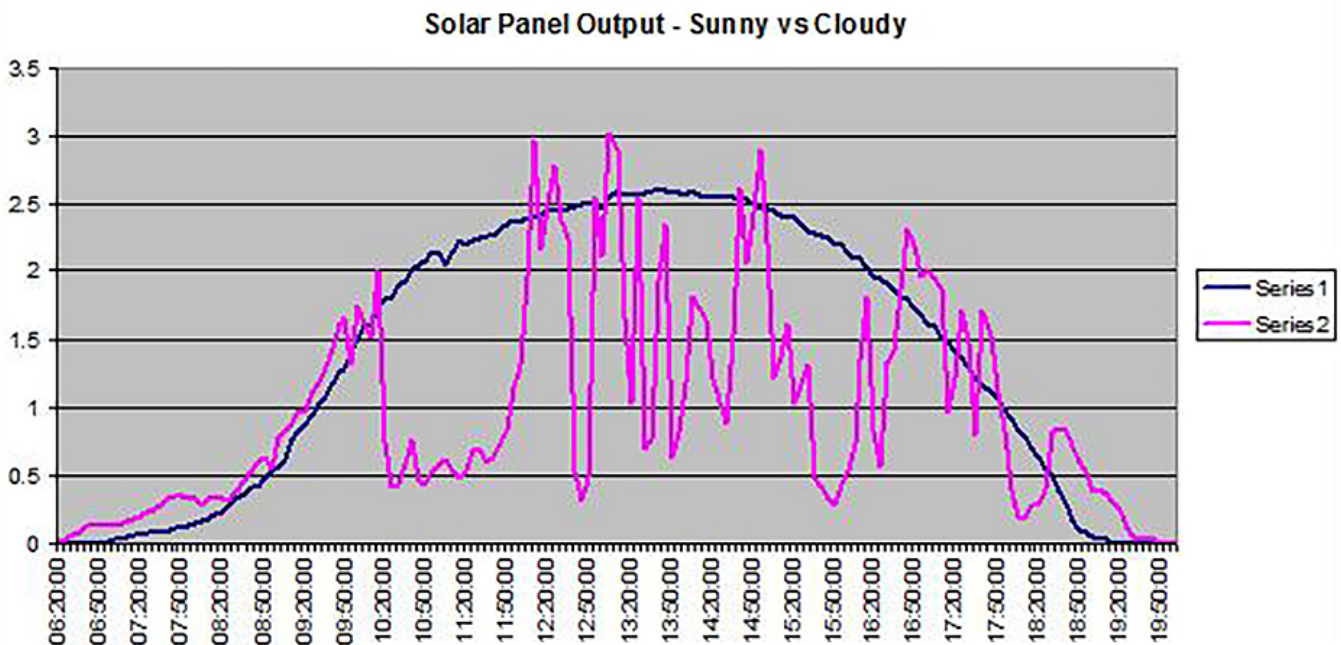

Figure 5. Solar panel output: sunny vs. cloudy

The benefit of energy storage is demonstrated when the bus frequency dips. The energy storage inverter outputs power to assist the generator set in responding to the transient, thus reducing the magnitude of frequency and voltage dips. The energy storage inverter can provide 250 kW continuously, up to the storage capacity of the battery. In transient operation, the inverter has higher power capability – 150 percent for 30 seconds or 200 percent for 3 seconds. The battery capacity in this example can power the inverter for 10 minutes at 250 kW.

An additional benefit of the energy storage inverter is the overall improvement in diesel power efficiency. The energy storage system can supply operating reserve or spinning reserve for the power plant. As the power plant load rises, additional generator sets are usually started when the operating load reaches 80 to 90 percent of the running generator sets’ capacity. This provides extra capacity to respond to transient loads. Using the stored energy as operating reserve allows the system operator to wait to dispatch additional generator sets until the power system load is 95 to 100 percent of the running units’ capacity. The overall average load of the diesel generator sets is therefore higher, resulting in higher overall power plant efficiency.



Figure 6. Typical thin-film PV array on racking system and clips

The Cat microgrid control system can be used with or without energy storage in an existing power plant to control the network and integrate with all energy sources to provide coordinated control of the diesel generator sets, wind power energy sources, energy storage and PV panels. This is important because high reliance on renewable generation may cause voltage on some power feeder circuits to rise. The microgrid controls automatically adjust to maintain system voltage and power quality within specifications. The controller monitors generator set operation and maintains minimum load levels on the diesel generator sets in response to set points determined by the operator.

Where fuel consumption information is available, the microgrid controller can be used to dispatch the most efficient generator set or a combination of generator sets for a particular operating mode.

CONCLUSION

One way to simplify a project is to select a partner with deep experience in power systems, specifically hybrid microgrids. This partner should demonstrate experience in installing and integrating these systems and employ locally based service technicians who can provide support ranging from basic planned maintenance to comprehensive long-term service agreements. The ideal organization should be qualified to manage whole-project engineering, procurement and construction, while supplying all major components and ancillary equipment.

Another strong attribute is diverse financing capability with experienced, hands-on knowledge of the special needs of power projects. This can include the capability to provide financing beyond generating equipment to include the entire power infrastructure, along with offering flexible programs to suit specific needs. Project construction financing is especially helpful, providing a bridge loan while the project is being built and not yet producing cash flow. It then converts to long-term financing when the project is substantially complete.

The low and declining cost of solar PV and wind energy opens new possibilities for clean, reliable and affordable electric power in hybrid microgrid configurations. Microgrids can be quickly and cost-effectively implemented in remote locations beyond the reach of the utility grid or where the grid is unstable. These are opportune times to investigate the hybrid microgrid concept as an alternative to conventional power generation.

ABOUT

About the Authors

Francois-Xavier Saury is Microgrid Business Development Manager for Europe, Africa, the Middle East and the Commonwealth of Independent States with Caterpillar Inc. and is based in Geneva, Switzerland. He can be reached at Saury_Francois-Xavier@cat.com.

Craig Tomlinson is Product Support Readiness Manager with the Microgrid Team in the Electric Power Division Of Caterpillar Inc. and is based on Houston, Texas. He can be reached at Tomlinson_Craig_C@Cat.com.

About Caterpillar

For nearly 90 years, Caterpillar Inc. has been making sustainable progress possible and driving positive change on every continent. Customers turn to Caterpillar to help them develop infrastructure, energy and natural resource assets. With 2014 sales and revenues of \$55.2 billion, Caterpillar is the world's leading manufacturer of construction and mining equipment, diesel and natural gas engines, industrial gas turbines and diesel-electric locomotives. The company principally operates through its three product segments – Resource Industries, Construction Industries and Power Systems – and also provides financing and related services through its Financial Products segment. For more information, visit caterpillar.com. To connect with us on social media, visit caterpillar.com/social-media.

Cat Gas Solutions: catgaspower.com

Online Community: caterpillar.lithium.com/t5/Electric-Power-Generation/ct-p/EPG

YouTube: youtube.com/CatPowerGeneration

Contact a Dealer: cat.com/dealer-locator

BUILT FOR IT.™

LEXE0904-00 February 2016

© 2016 Caterpillar. All Rights Reserved. CAT, CATERPILLAR, BUILT FOR IT, their respective logos, "Caterpillar Yellow," the "Power Edge" trade dress, as well as corporate and product identity used herein, are trademarks of Caterpillar and may not be used without permission.